

BW 31-56 Mounting Bracket

- With protective cover
- Adjustable
- Robust design
- Mounting materials included in scope of delivery

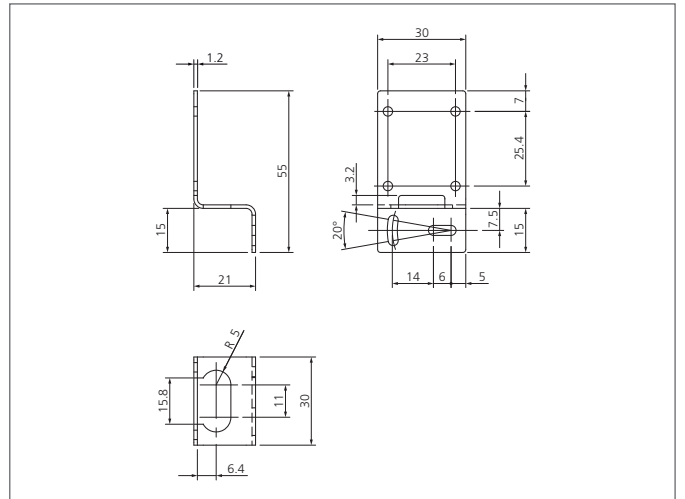
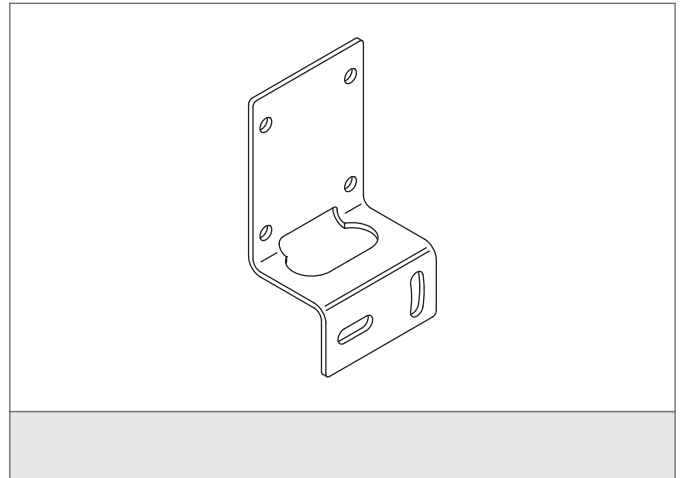

TECHNICAL INFORMATION (typ.)

Hole spacing	25.4 mm
Mounting	hole
For	Sensors Opto Series 30 with cable or pig-tail output
Casing material	stainless steel
Scope of delivery	Mounting bracket, Fixing material